

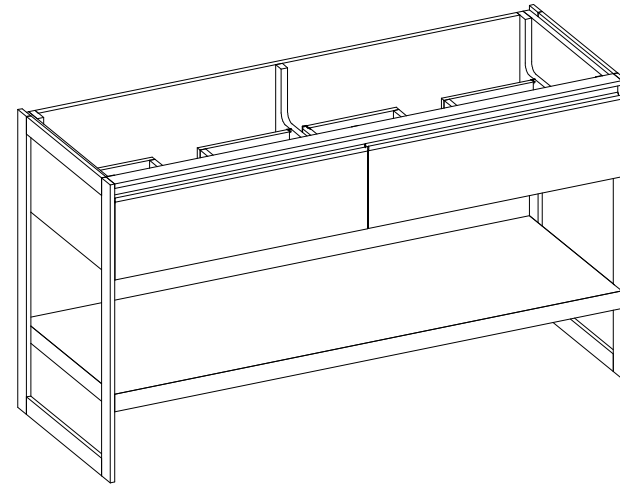

SHOWN WITHOUT BRACE

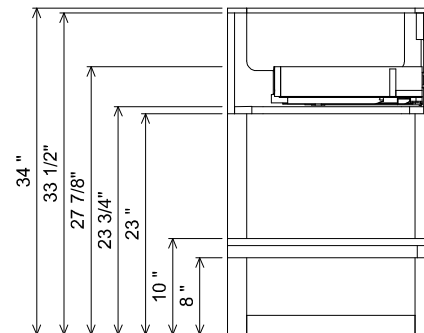

AT SINK CENTER SECTION

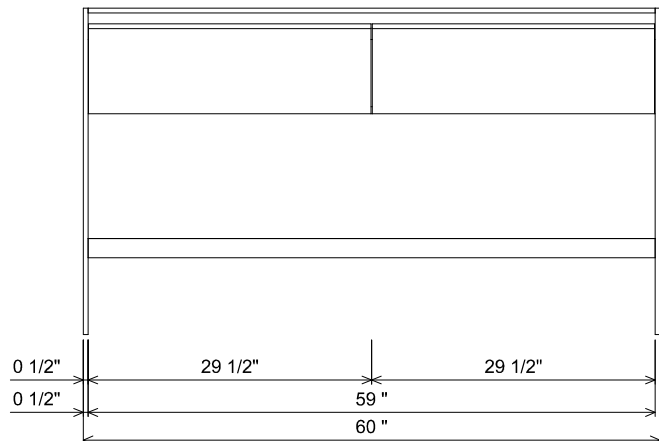

 THE FURNITURE GUILD <small>ESTD 1984</small>	0621-0260	<small>ALL DRAWINGS AND DIMENSIONS ARE SUBJECT TO CHANGE WITHOUT NOTICE AT THE DISCRETION OF THE MANUFACTURER. THE MANUFACTURER RESERVES THE RIGHT TO MAKE ADDITIONS, DELETIONS, AND MODIFICATIONS TO THE DRAWINGS AS THE MANUFACTURER MAY DEEM APPROPRIATE OR DESIRABLE. DIMENSIONS ARE APPROXIMATE AND MAY VARY WITH ACTUAL CONSTRUCTION. PLEASE CONTACT THE FURNITURE GUILD, INC. TO ENSURE DRAWING IS UP TO DATE.</small> <small>THE INFORMATION CONTAINED IN THIS DRAWING IS THE SOLE PROPERTY OF THE FURNITURE GUILD, INC. ANY REPRODUCTION IN PART OR AS A WHOLE WITHOUT WRITTEN PERMISSION OF THE FURNITURE GUILD, INC. IS PROHIBITED.</small>
	AVENTO	
	CURRENT AS OF: 02/01/2019	