

**Features**

- Drawers and interior finished to match exterior
- Grain Direction is Horizontal on Drawer Fronts
- Grain Direction is Vertical on Doors
- Grain Direction is Vertical on Sides

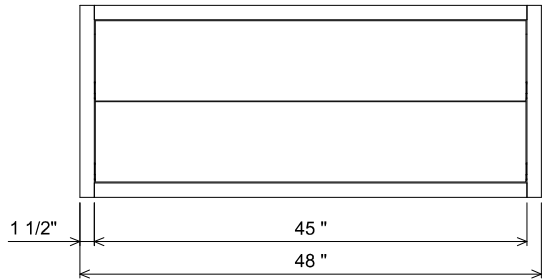

AT SINK CENTER SECTION

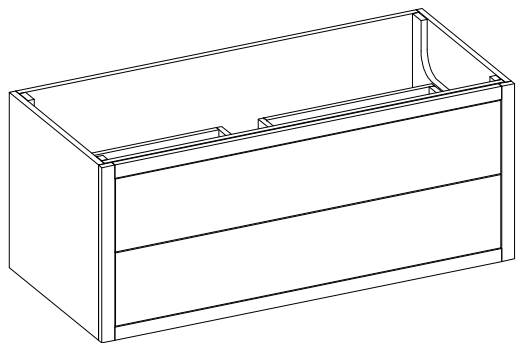
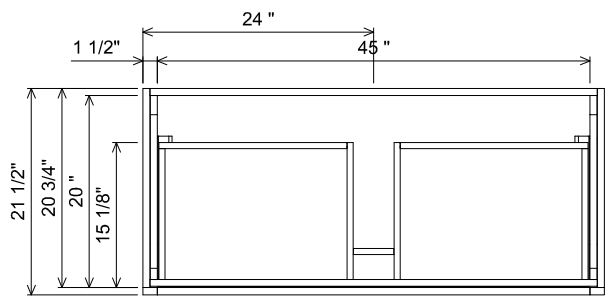
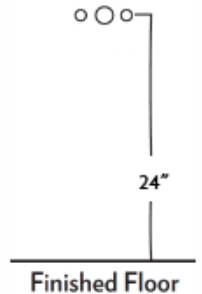
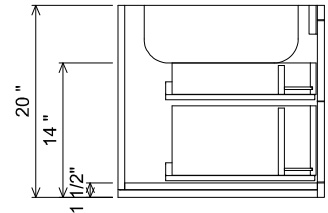

**PREPARATION INSTRUCTIONS**  
 All vanities require solid blocking in the wall  
 Plumbing supply and waste to be 24"H above finished floor  
 Space for Undermount sink: 5 3/4"H

 <b>THE FURNITURE GUILD</b> <small>ESTD 1984</small>	105-0002-48	<small>ALL DRAWINGS AND DIMENSIONS ARE SUBJECT TO CHANGE WITHOUT NOTICE AT THE DISCRETION OF THE MANUFACTURER. THE MANUFACTURER RESERVES THE RIGHT TO MAKE ADDITIONS, DELETIONS, AND MODIFICATIONS TO THE DRAWINGS AS THE MANUFACTURER MAY DEEM APPROPRIATE OR DESIRABLE. DIMENSIONS ARE APPROXIMATE AND MAY VARY WITH ACTUAL CONSTRUCTION. PLEASE CONTACT THE FURNITURE GUILD, INC. TO ENSURE DRAWING IS UP TO DATE.</small>
	KAELYN	
	CURRENT AS OF:	05/17/2022