

Features

Drawers and interior finished to match exterior

Grain Direction is Horizontal on Drawer Fronts

Grain Direction is Vertical on Doors

Grain Direction is Vertical on Sides

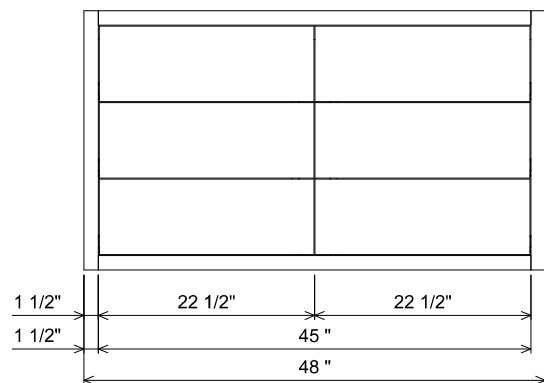
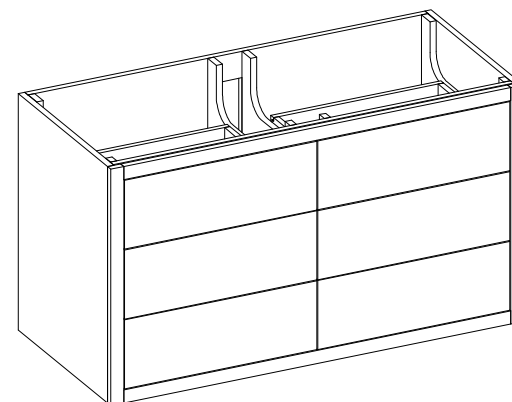
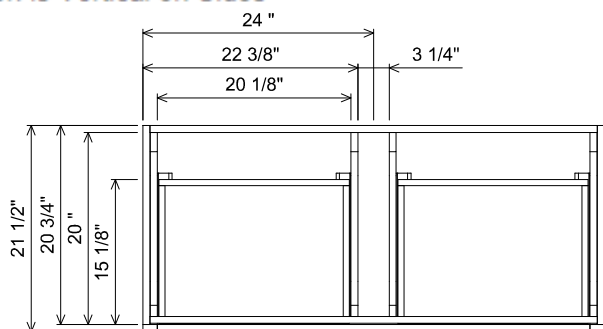

AT BANK SECTION

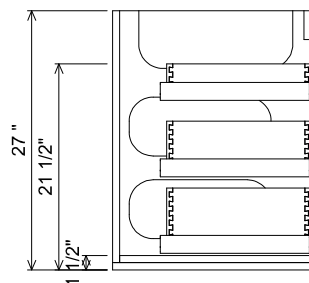

AT SINK CENTER SECTION

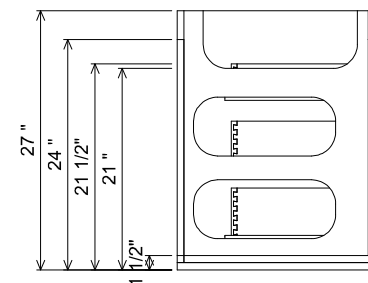

PREPARATION INSTRUCTIONS

All vanities require solid blocking in the wall

Plumbing supply and waste to be 24"H above finished floor

Space for Undermount sink: 4 3/4" H



THE
FURNITURE GUILD

ESTD 1984

106-0503-48

KAEYLYN

CURRENT AS OF: 08/16/2023

ALL DRAWINGS AND DIMENSIONS ARE SUBJECT TO CHANGE WITHOUT NOTICE AT THE DISCRETION OF THE MANUFACTURER. THE MANUFACTURER RESERVES THE RIGHT TO MAKE ADDITIONS, DELETIONS, AND MODIFICATIONS TO THE DRAWINGS AS THE MANUFACTURER MAY DEEM APPROPRIATE OR DESIRABLE. DIMENSIONS ARE APPROXIMATE AND MAY VARY WITH ACTUAL CONSTRUCTION. PLEASE CONTACT THE FURNITURE GUILD, INC. TO ENSURE DRAWING IS UP TO DATE.

THE INFORMATION CONTAINED IN THIS DRAWING IS THE SOLE PROPERTY OF THE FURNITURE GUILD, INC. ANY REPRODUCTION IN PART OR AS A WHOLE WITHOUT WRITTEN PERMISSION OF THE FURNITURE GUILD, INC. IS PROHIBITED.